

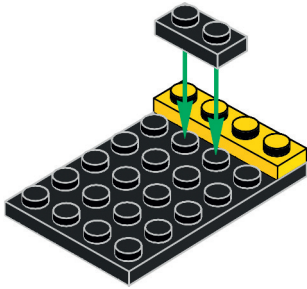

Rocket Sleigh

1



2

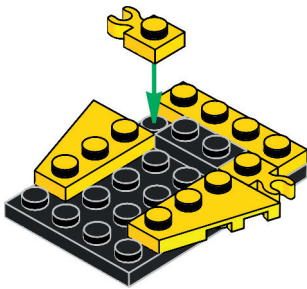

3

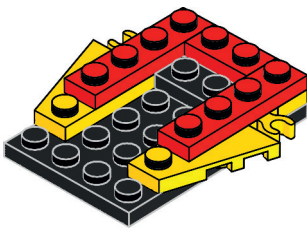

4

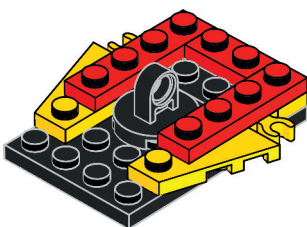

5

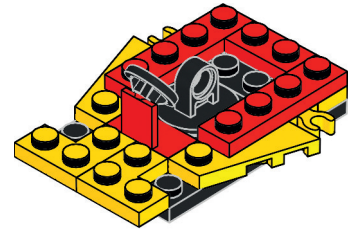

6

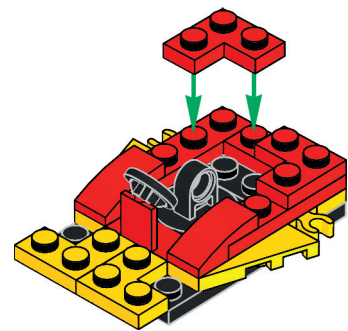

7

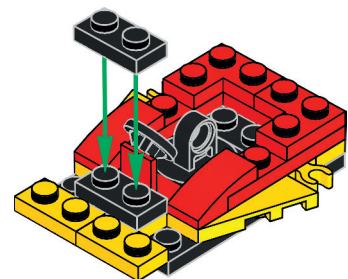

8

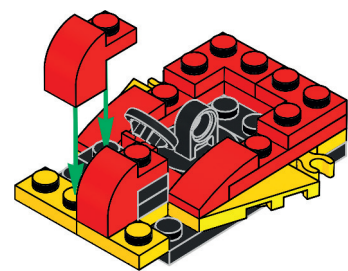

12

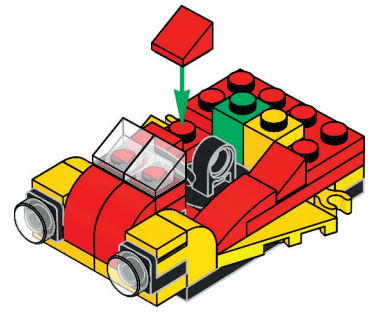

9

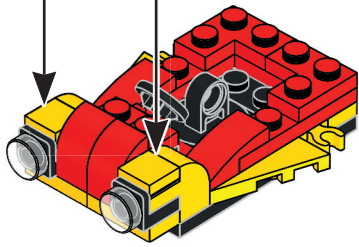
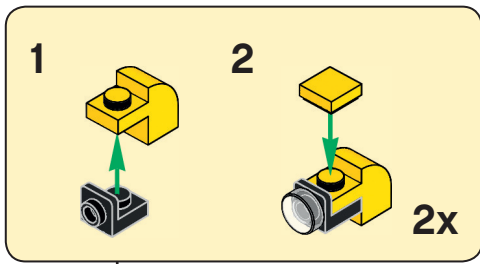

1

2

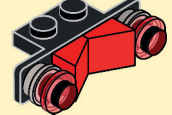
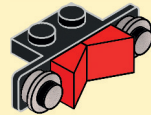

13

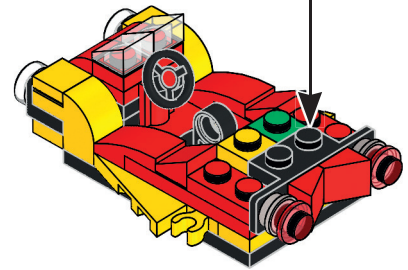

14

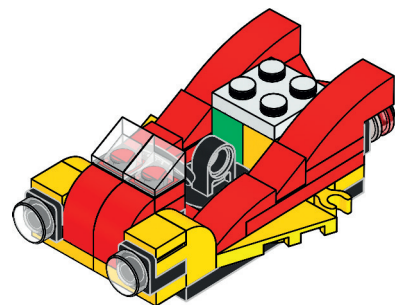

10

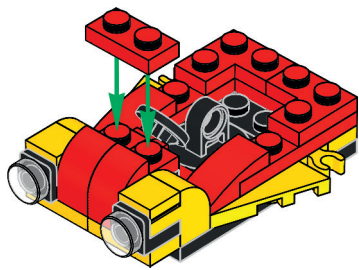

11

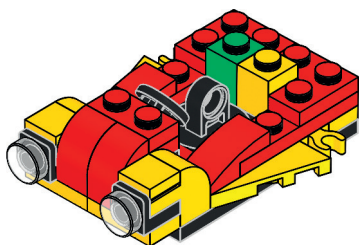

15

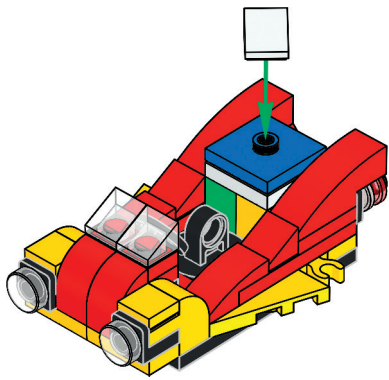

16

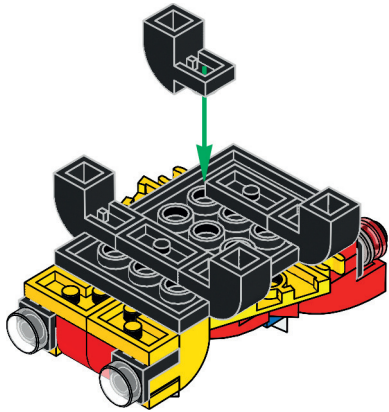

17

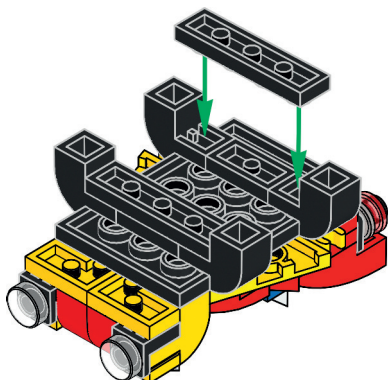

18

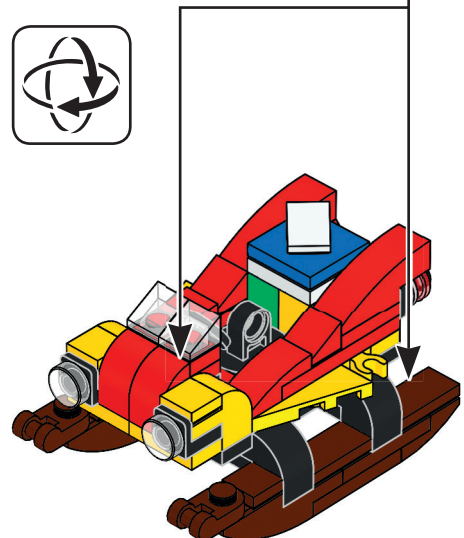

1

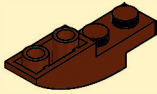

2

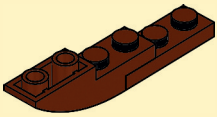

3

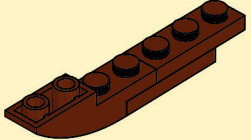

4

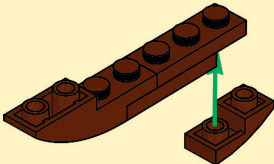



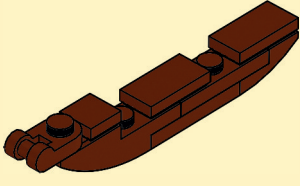





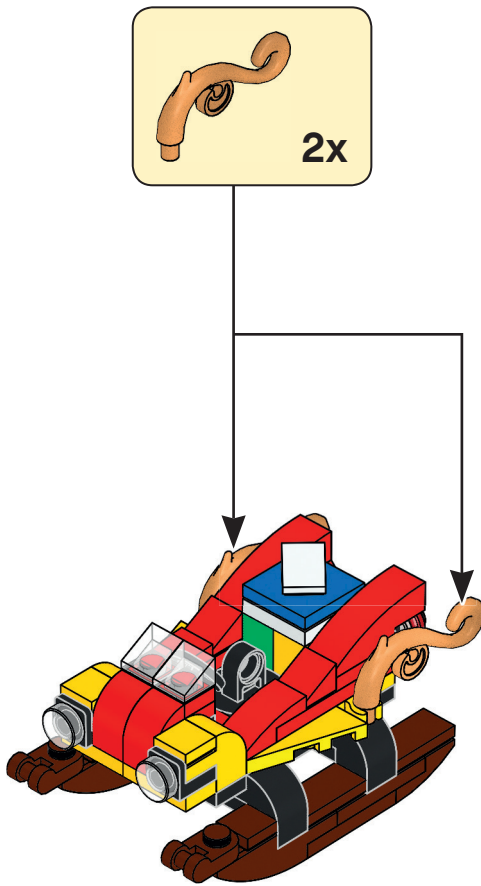





























5



2x

19



- | | |
|--|---|
|  |  |
| 1x 302201 | 1x 4504369 |
|  |  |
| 4x 4504379 | 1x 6168620 |
|  |  |
| 2x 6184782 | 2x 371026 |
|  |  |
| 1x 9552 | 1x 300528 |
|  |  |
| 2x 302321 | 2x 6274738 |
|  |  |
| 2x 6029946 | 2x 6245250 |
|  |  |
| 2x 242021 | 2x 6208450 |
|  |  |
| 2x 4251162 | 2x 4211288 |
|  |  |
| 2x 371021 | 2x 6153863 |
|  |  |
| 1x 6126049 | 4x 4211151 |
|  |  |
| 2x 307024 | 2x 6172922 |
|  |  |
| 1x 300524 | 4x 4211152 |
|  |  |
| 2x 6348065 | 2x 6092566 |
|  |  |
| 1x 4179095 | 2x 4633691 |
|  |  |
| 1x 4179094 | 2x 6234695 |
|  |  |
| 2x 4188357 | 1x 6010831 |
|  |  |
| 2x 242024 | 4x 6184784 |
|  |  |
| 1x 371024 | 5x 302326 |
|  |  |
| 2x 6172437 | 1x 303226 |