

朗豪坊 x LEGO
白色聖誕

LANGHAM PLACE x LEGO:
WHITE CHRISTMAS

Ages 12+

Christmas
Elf Café

835pcs



1

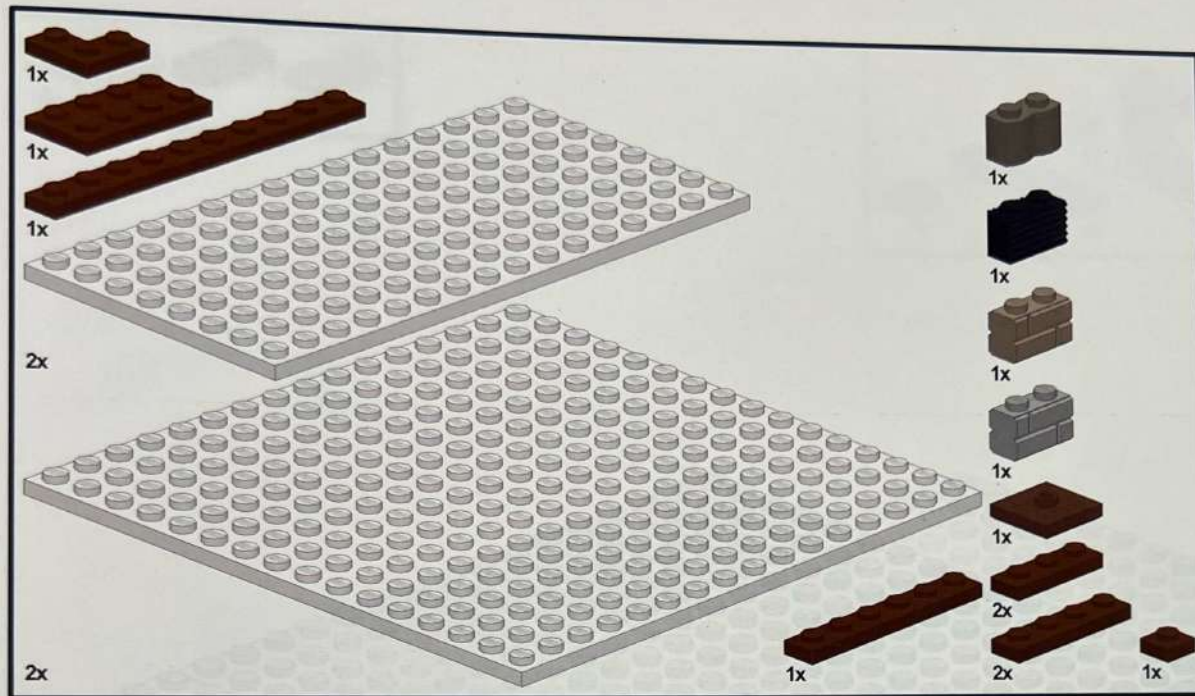

2

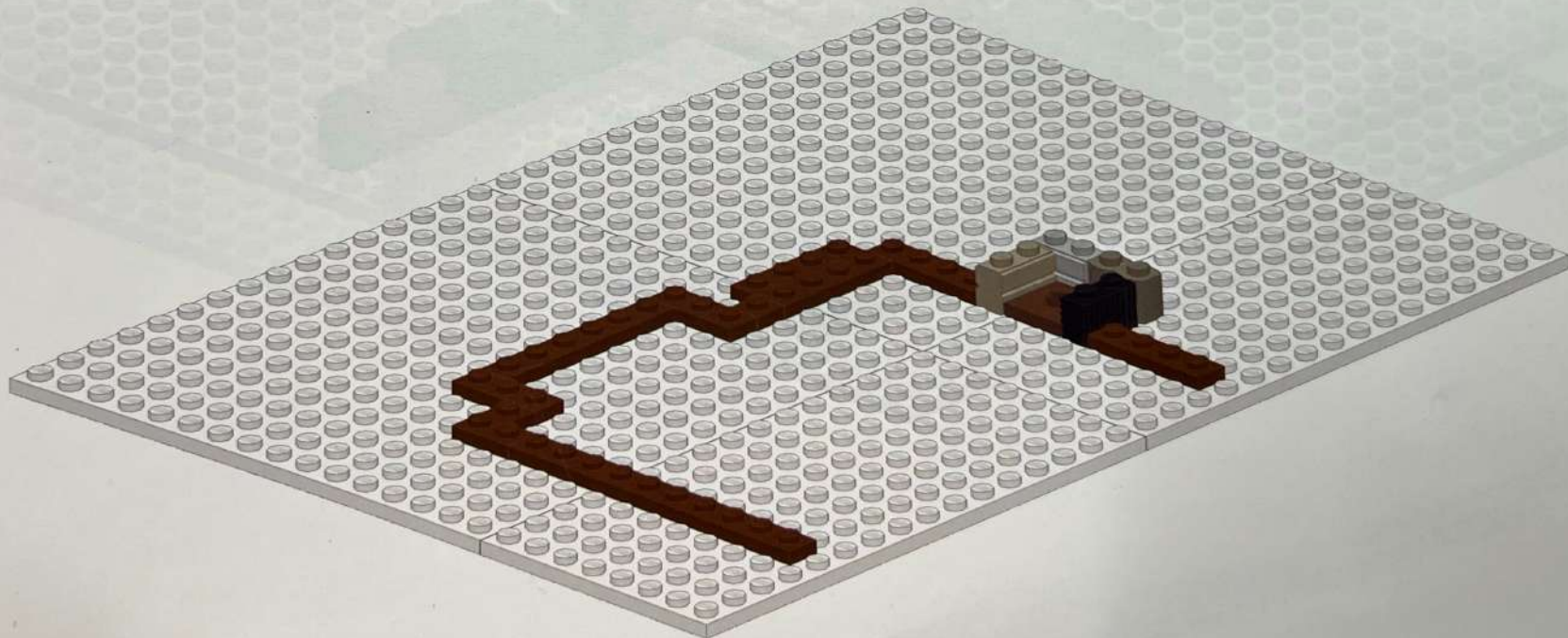

2

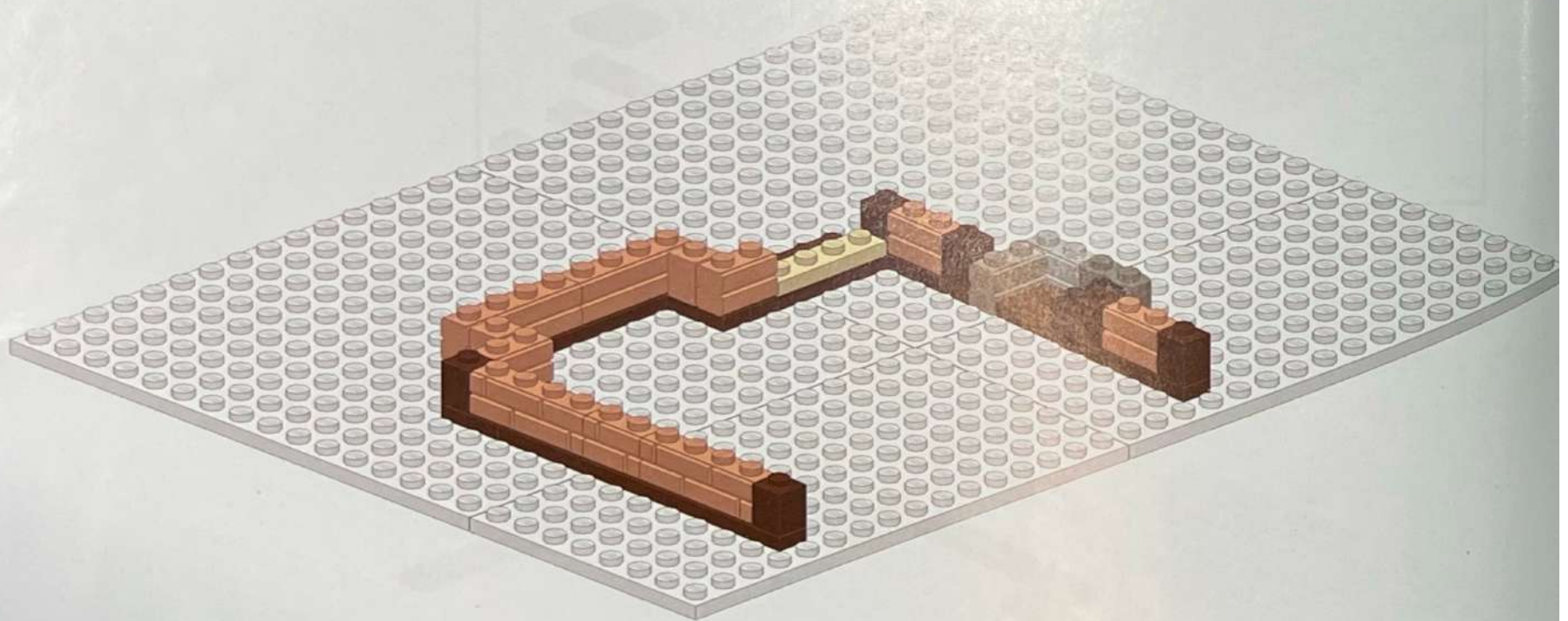
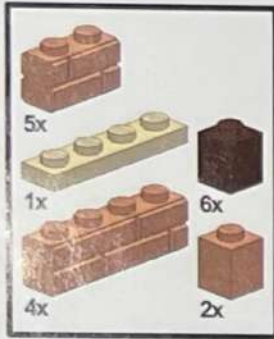

3

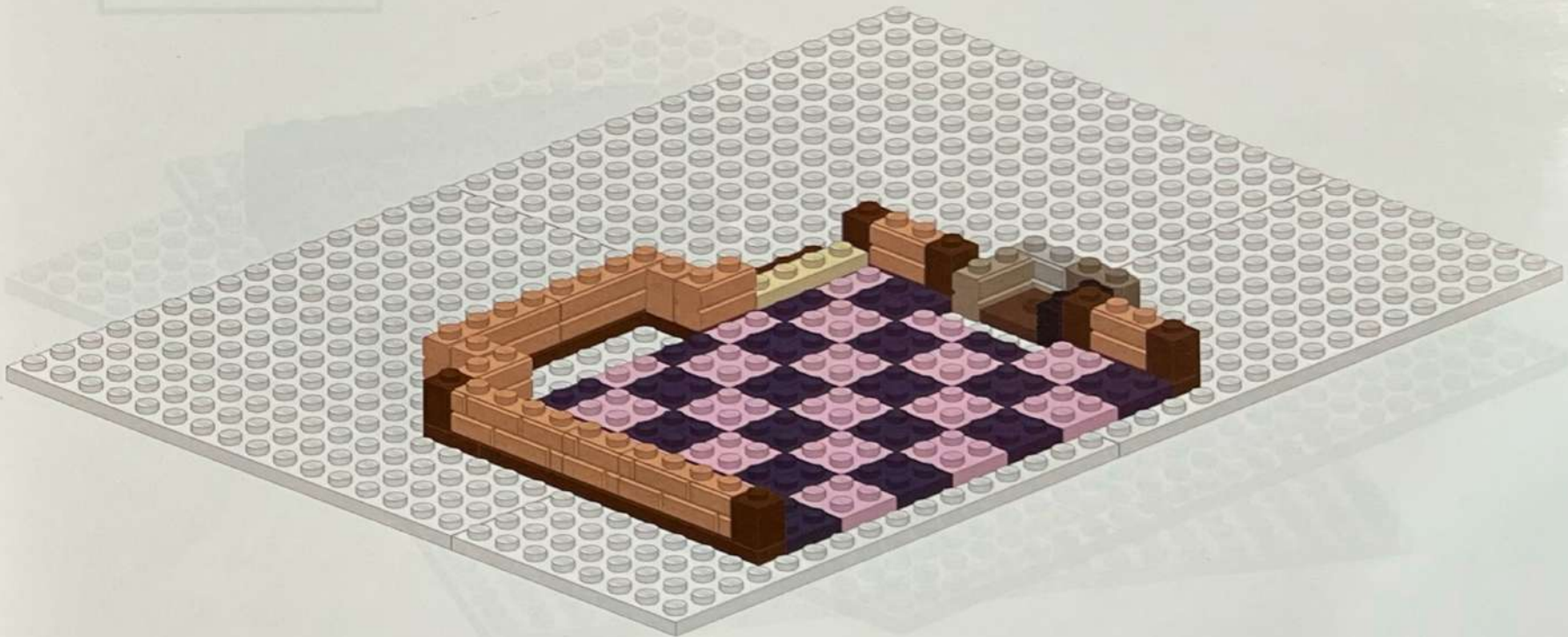

4

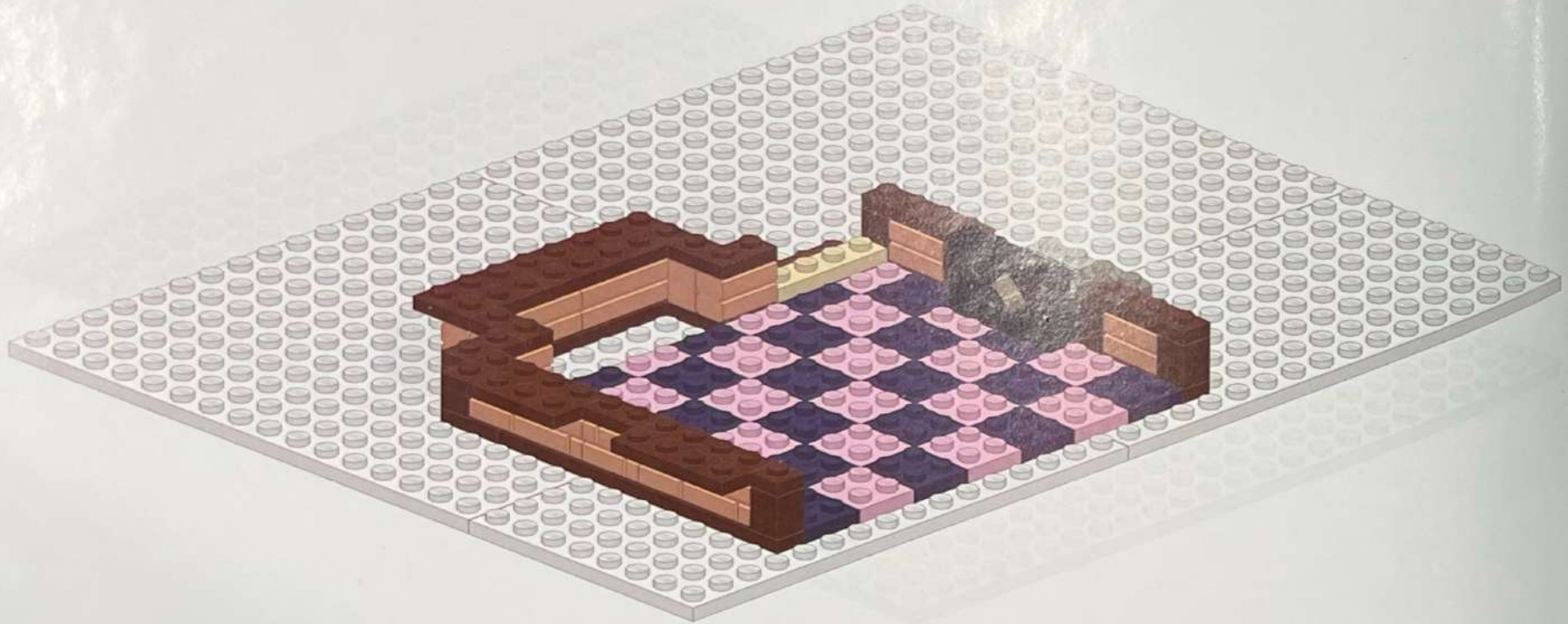
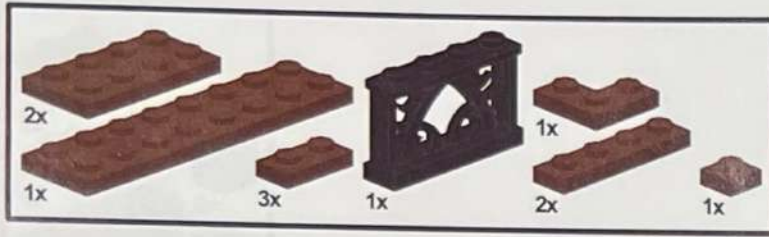

5

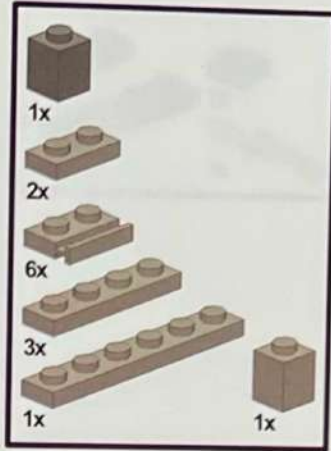

6

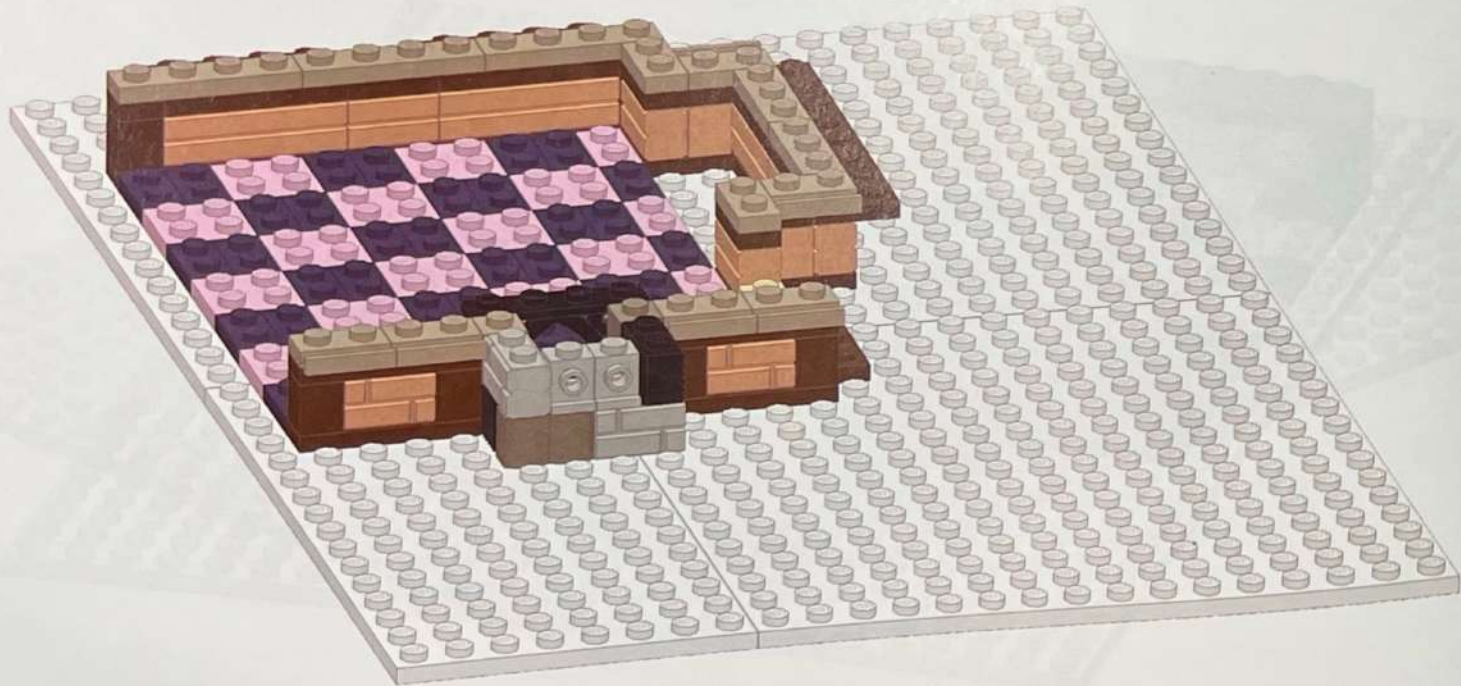

7

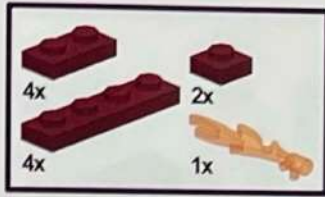

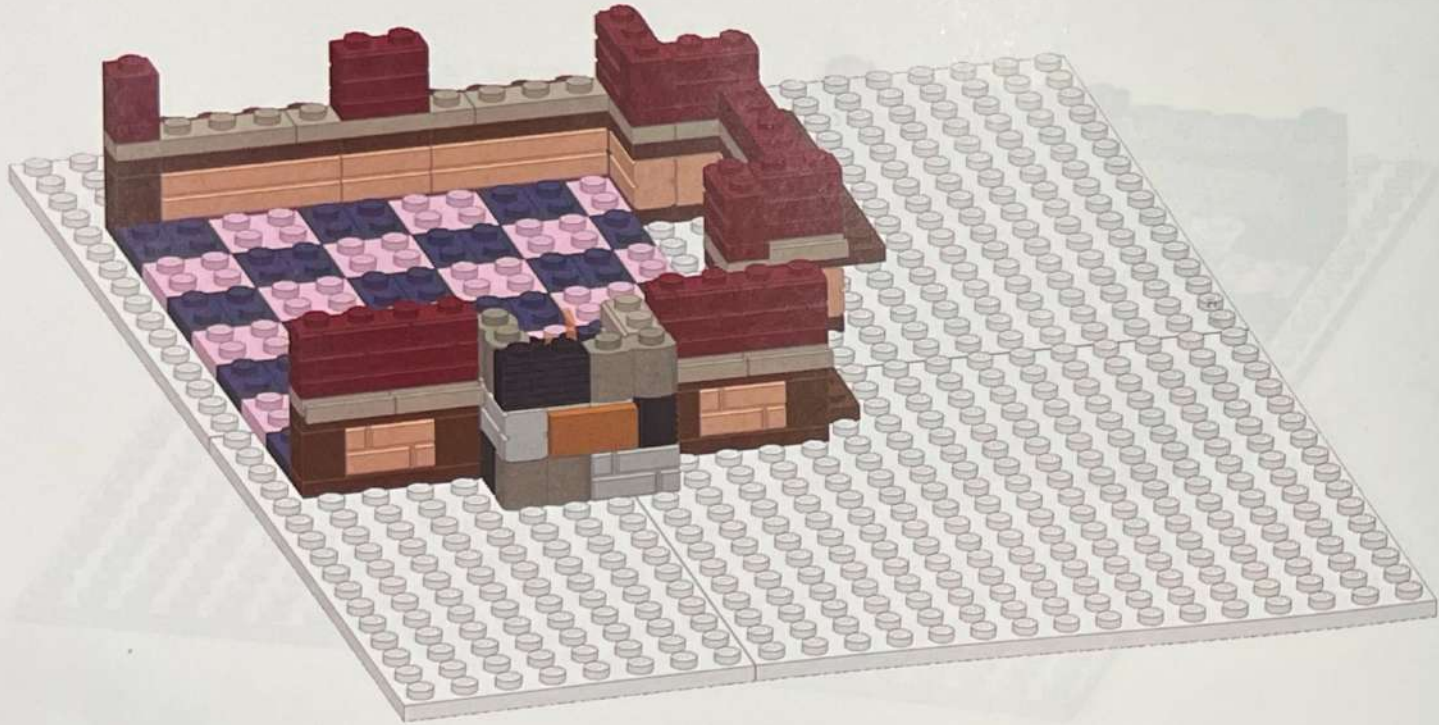
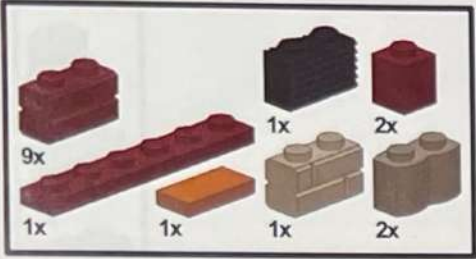

9

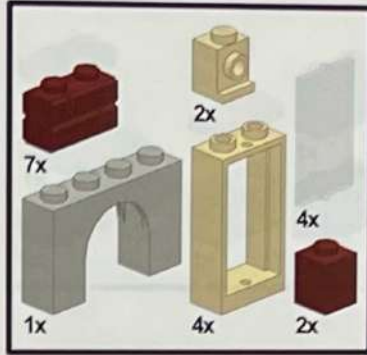

10

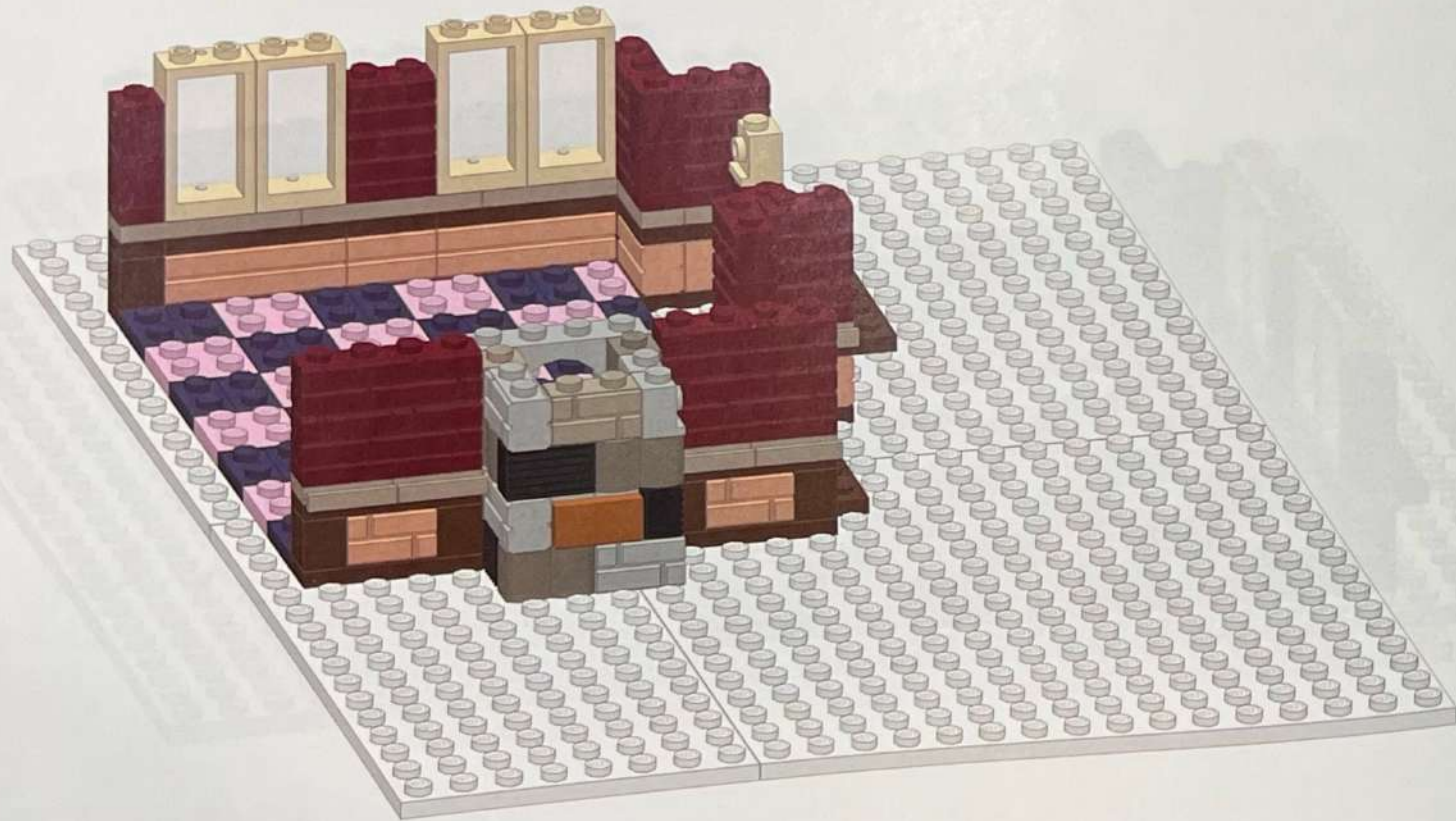

12

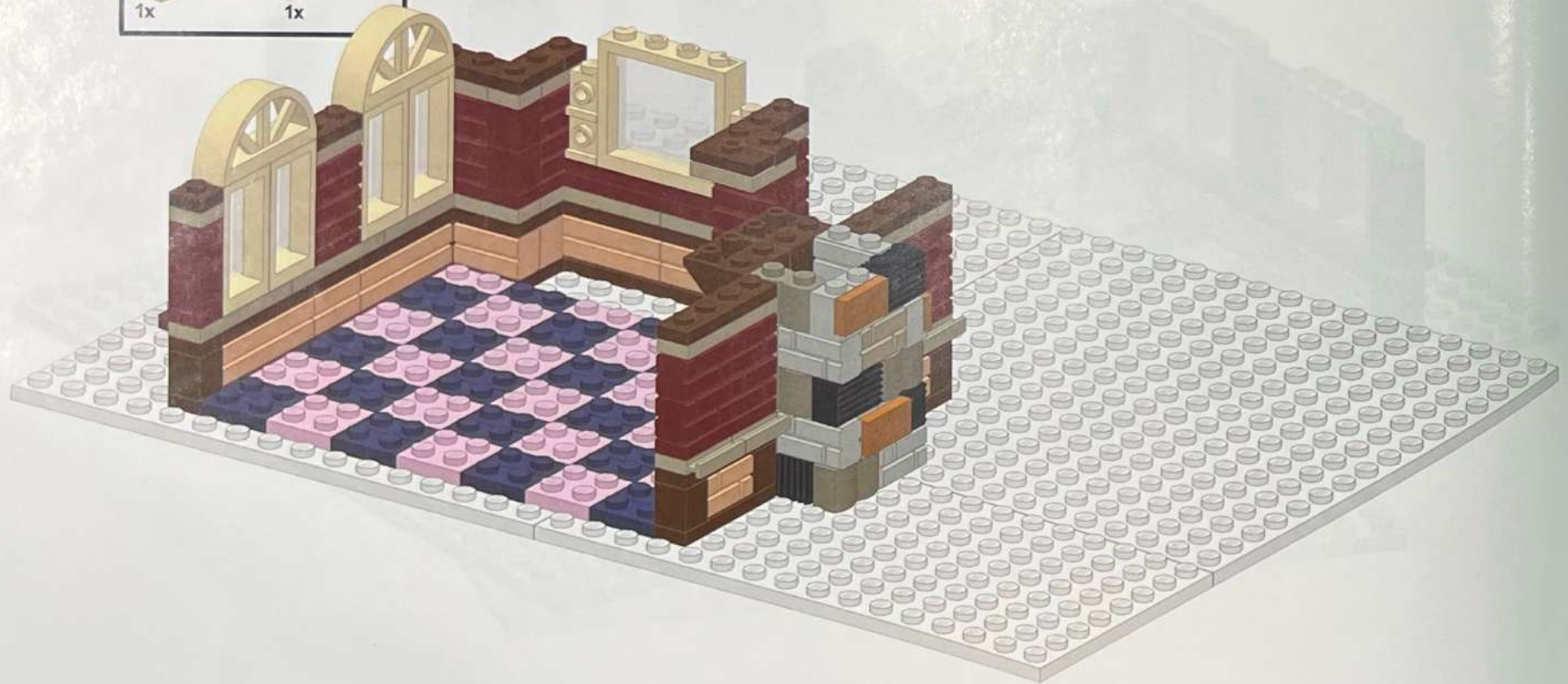
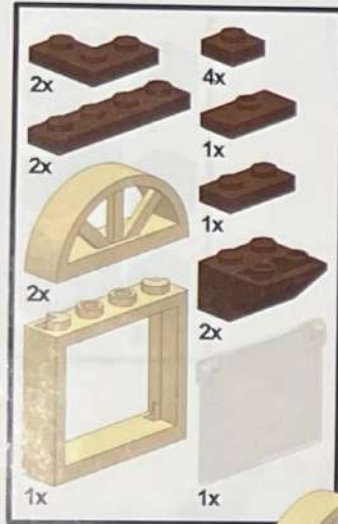

13

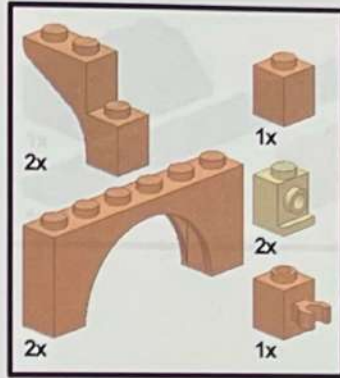

14

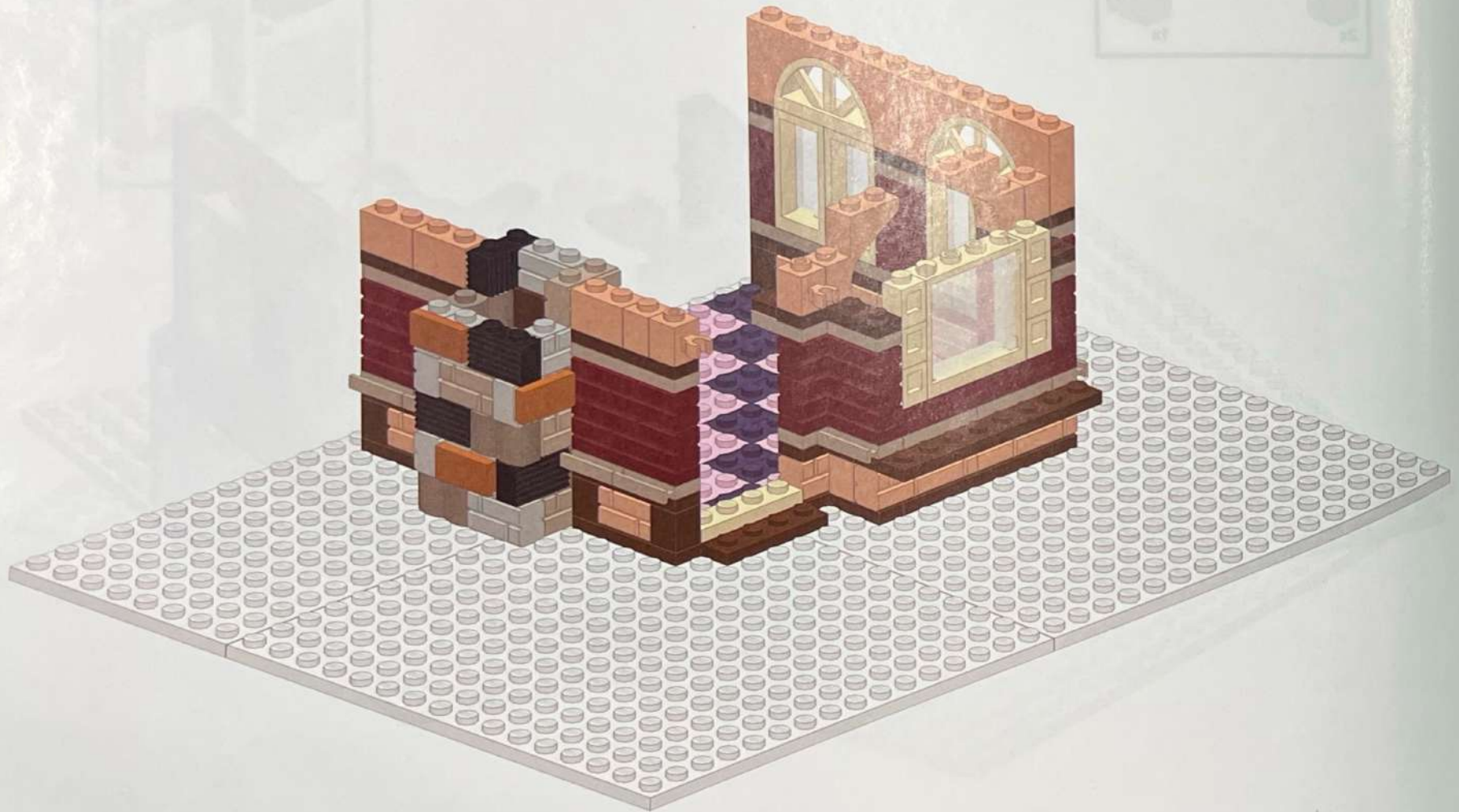
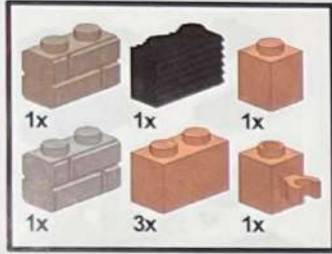

15

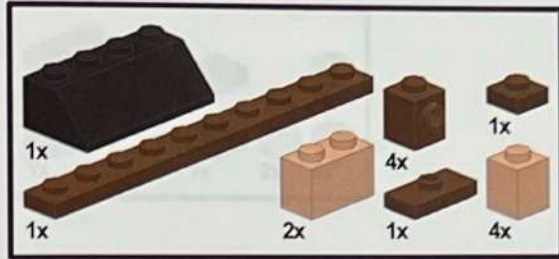

16

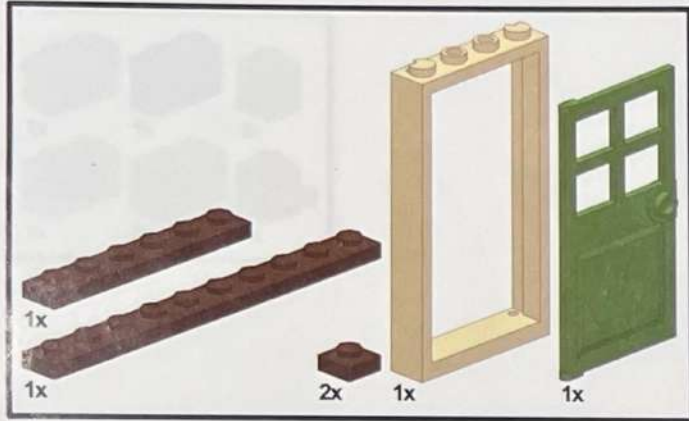

17

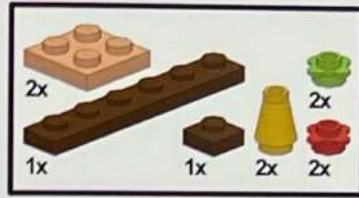

18

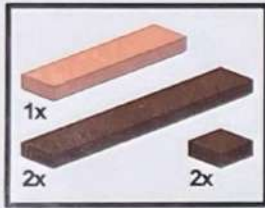

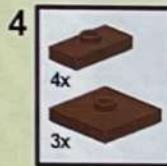
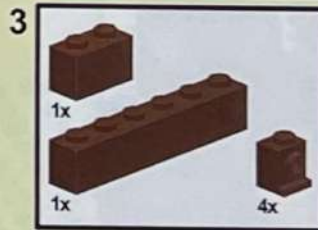
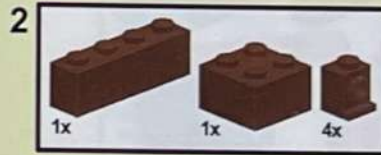





1

1x
1x
2x
6x

2

1x
1x
1x

3

1x
2x
2x

4

2x
2x



5
4x



6
2x



7
1x
1x

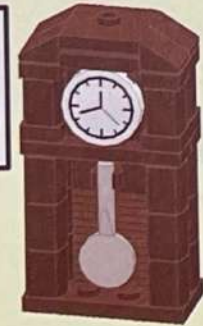

20



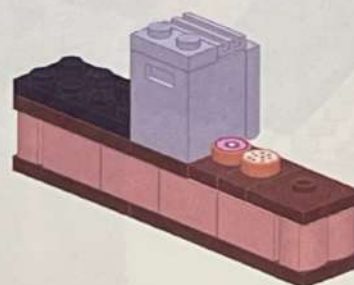
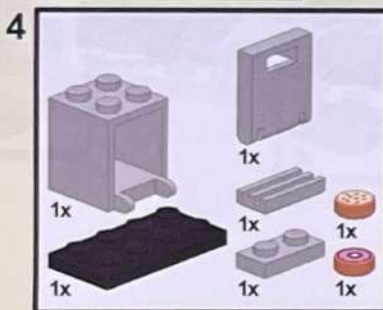
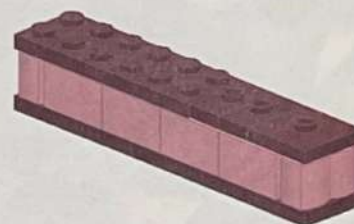
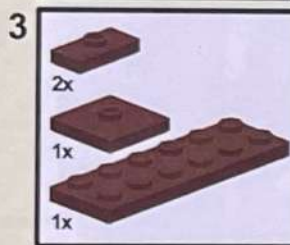
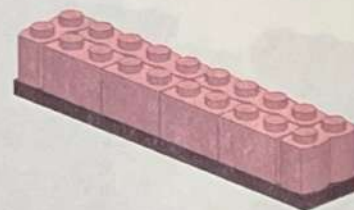
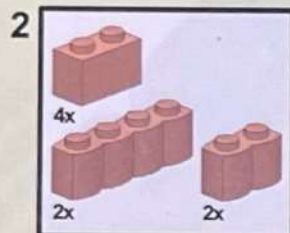
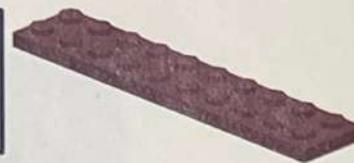

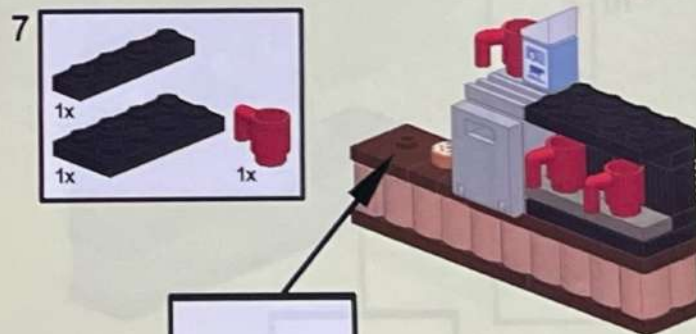
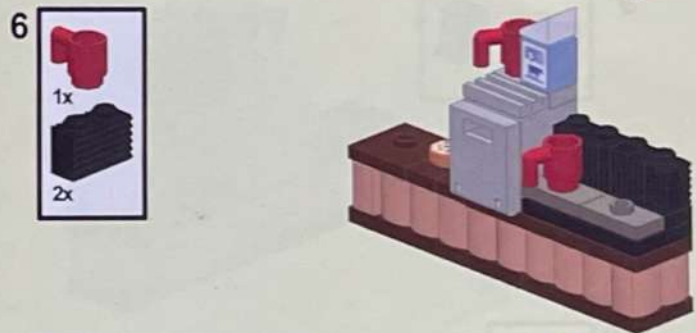
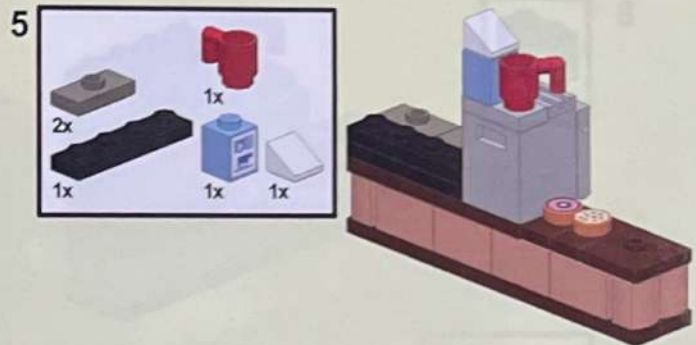



8

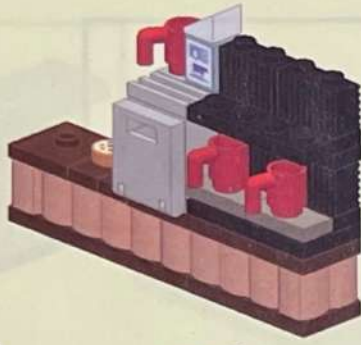

9

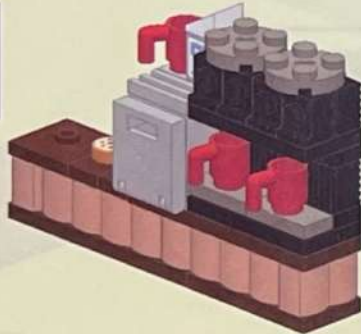
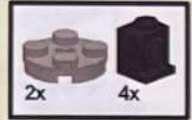

10

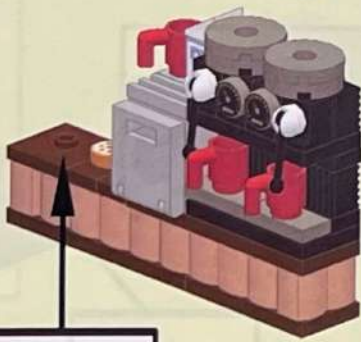
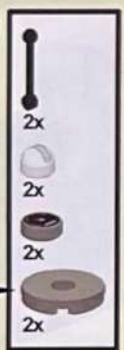

21



22



23

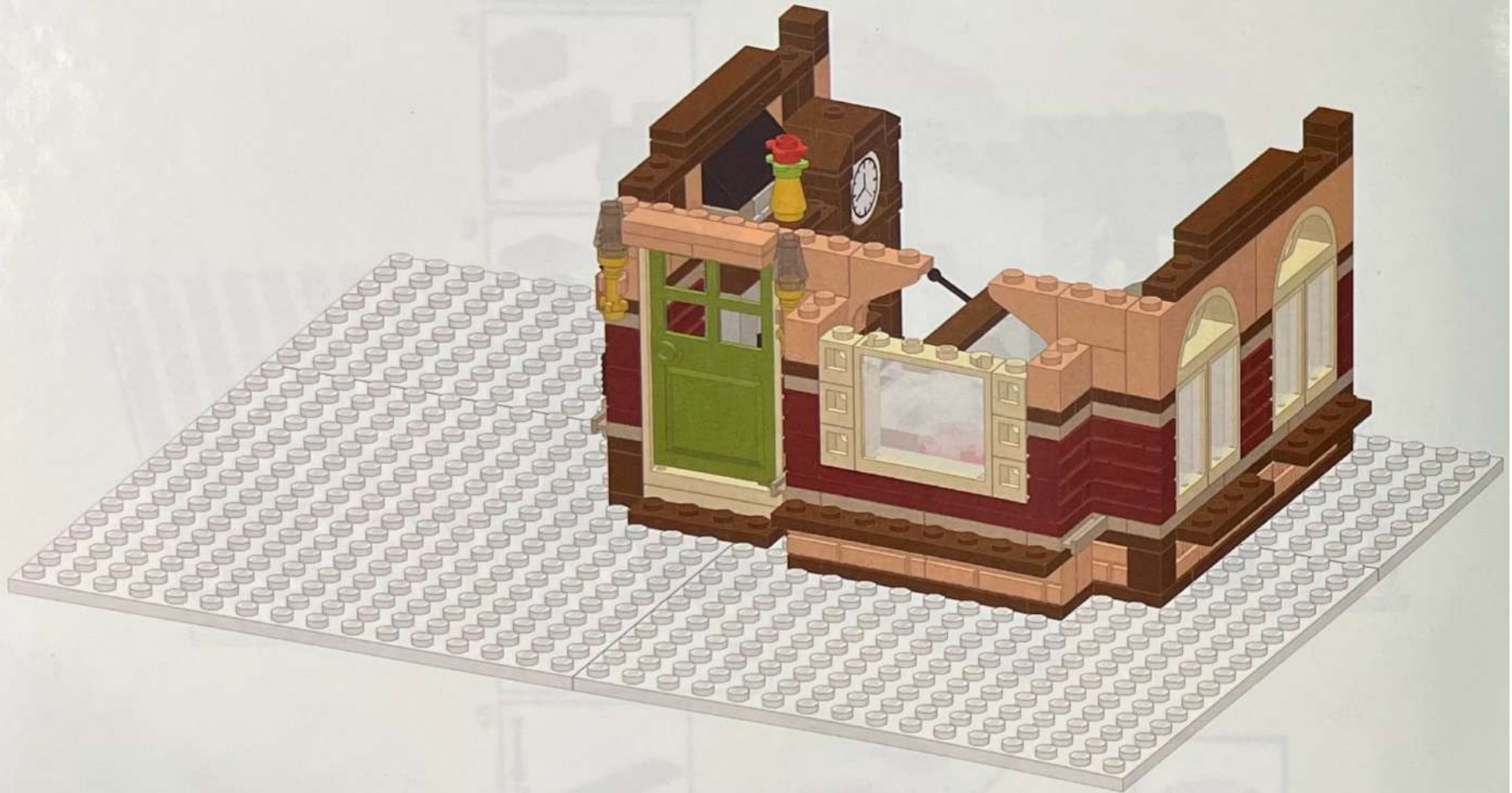
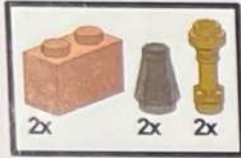



1

1x
1x
1x

2

4x 4x

3

3x

25

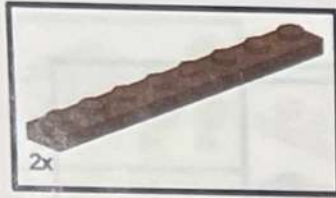

26



27

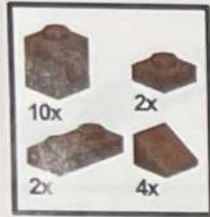

28

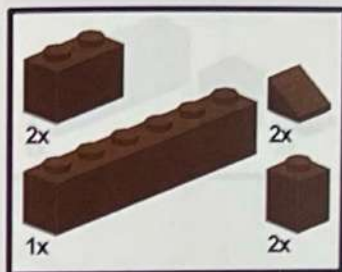

29

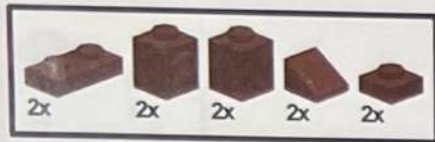

30

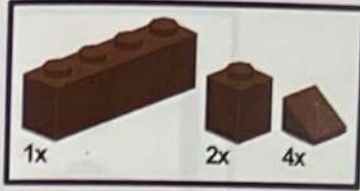

31



32

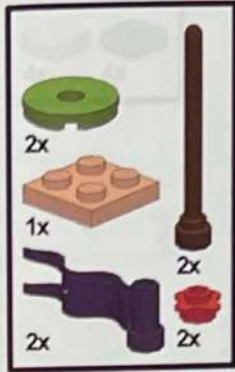

33



34

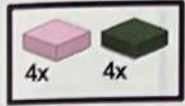

35

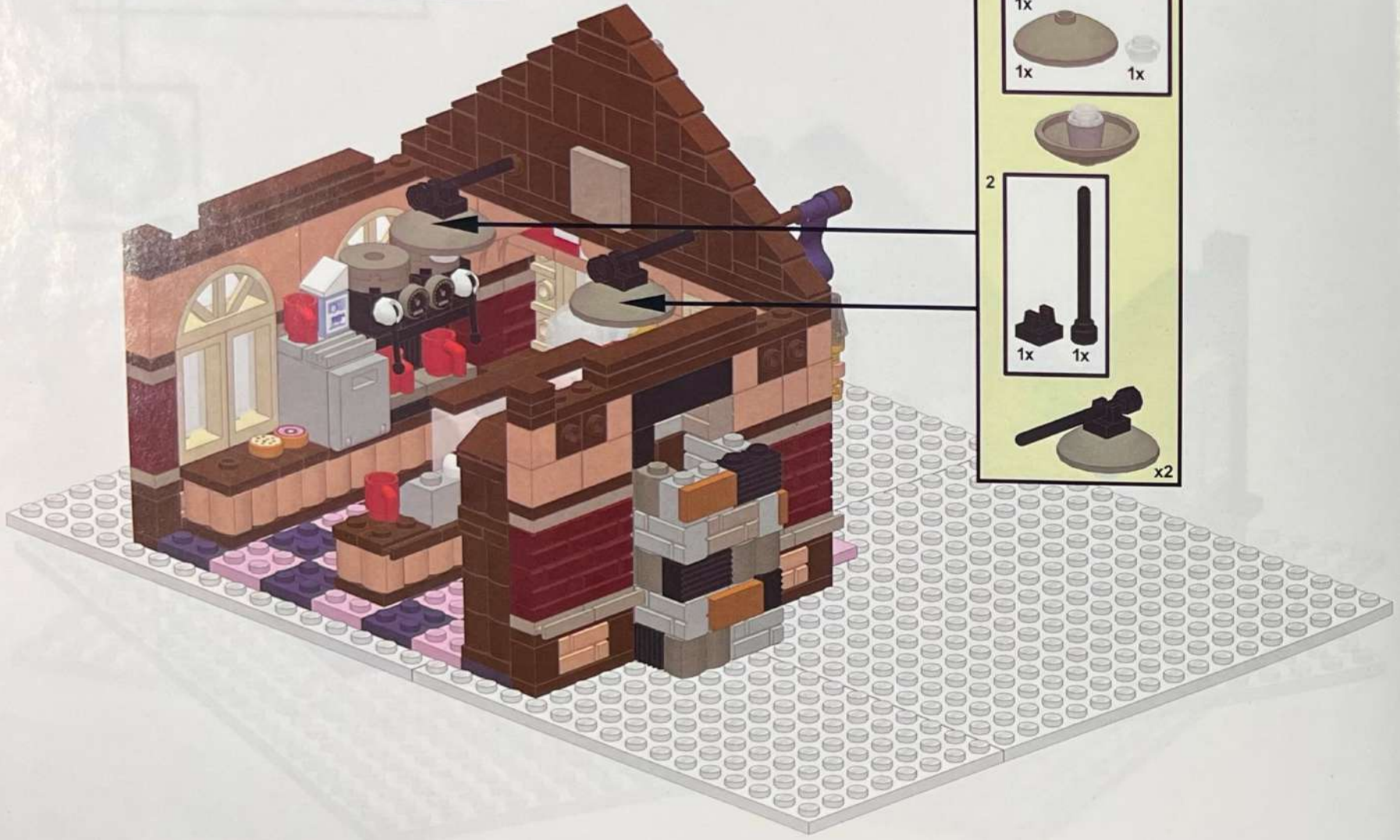
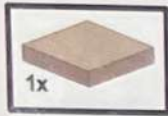

1

- 1x
- 1x
- 1x

2

- 1x
- 1x

x2

36



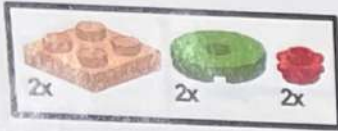

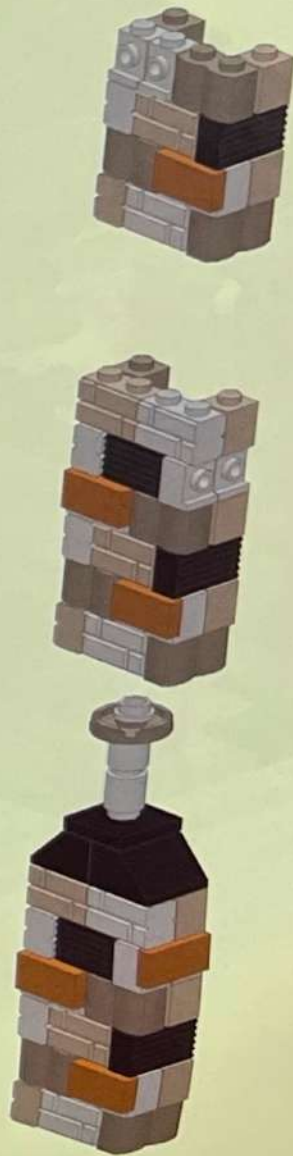



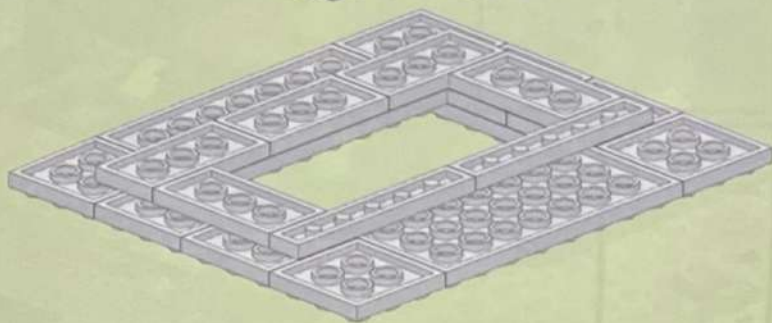
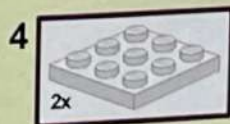
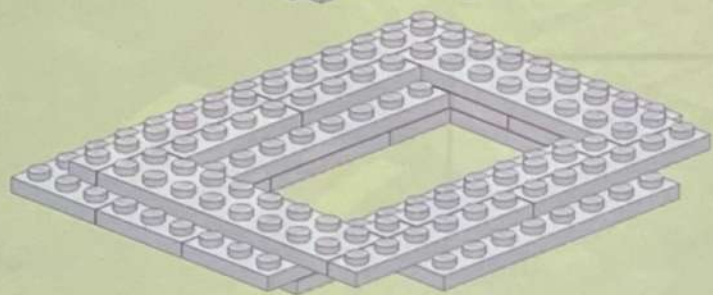
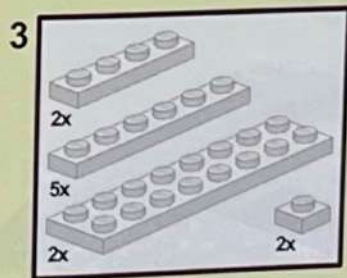
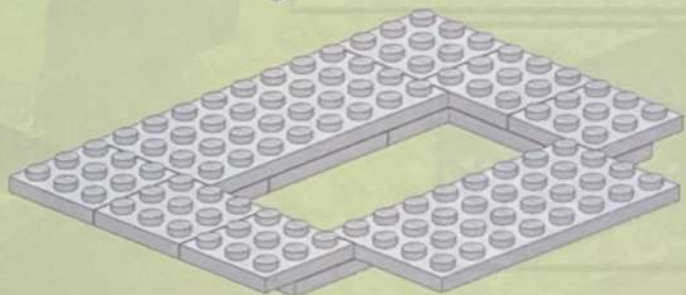
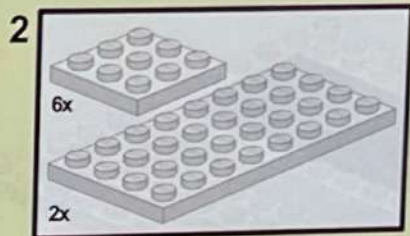
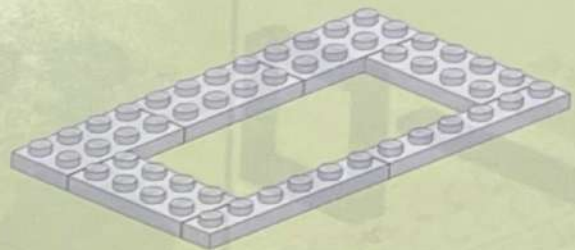
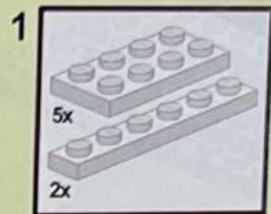

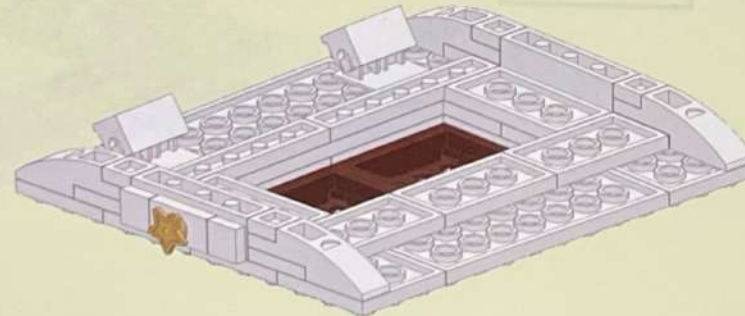
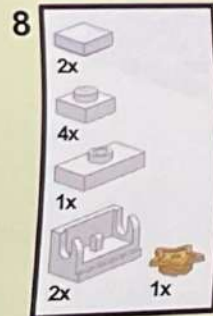
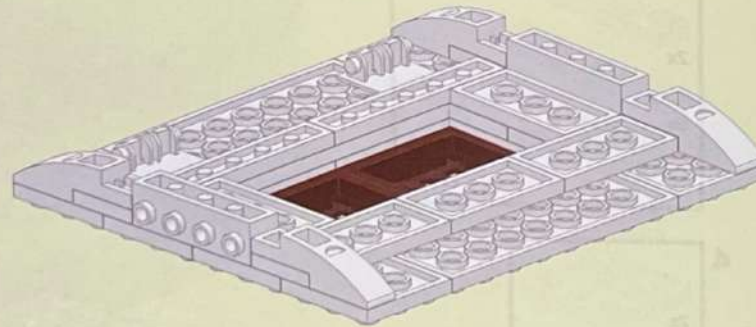
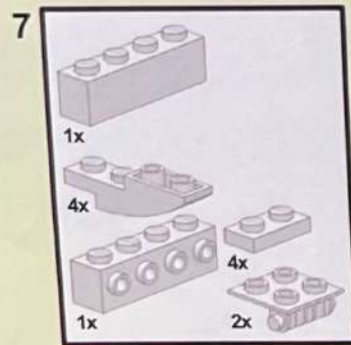
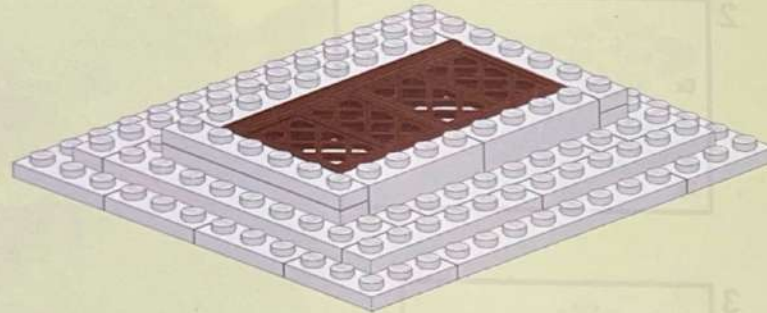
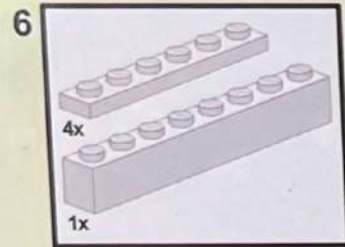
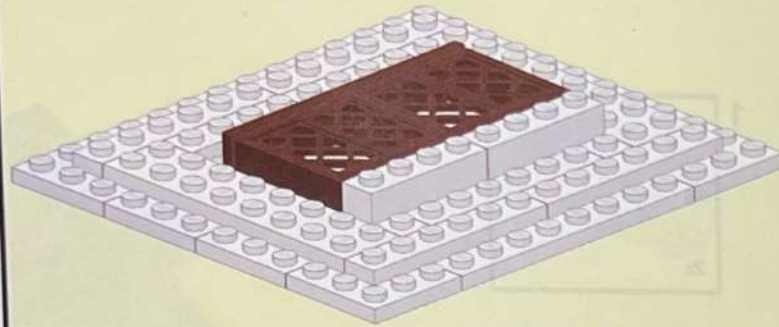
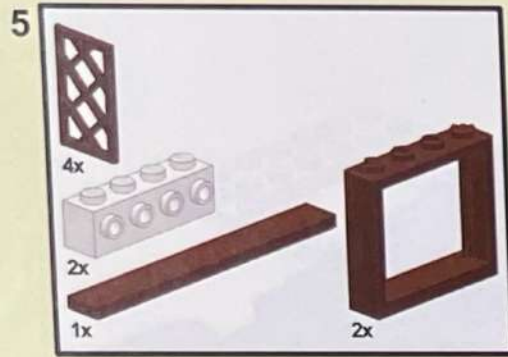

39



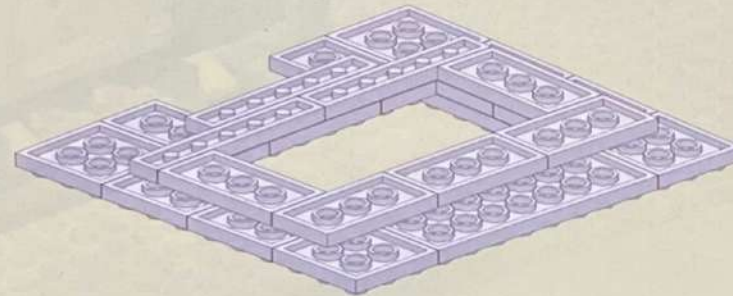
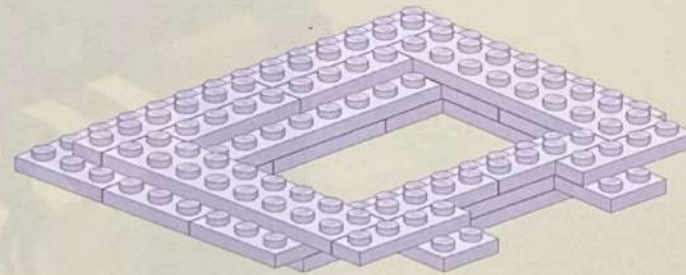
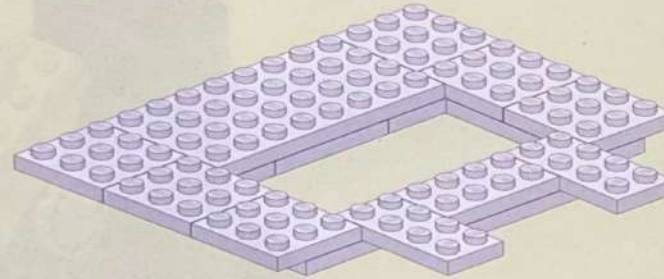
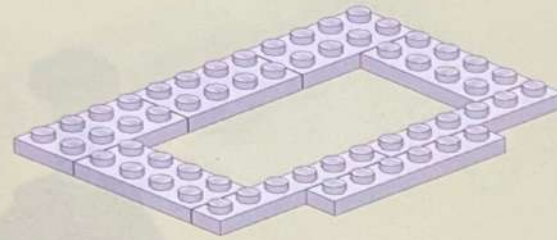
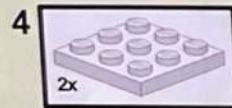
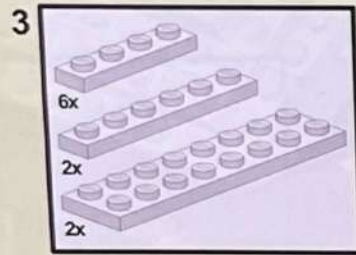
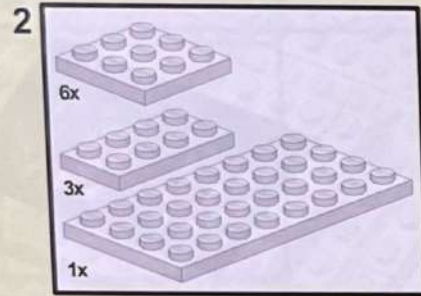
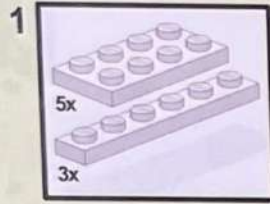

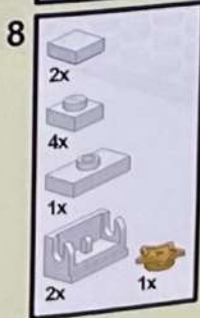
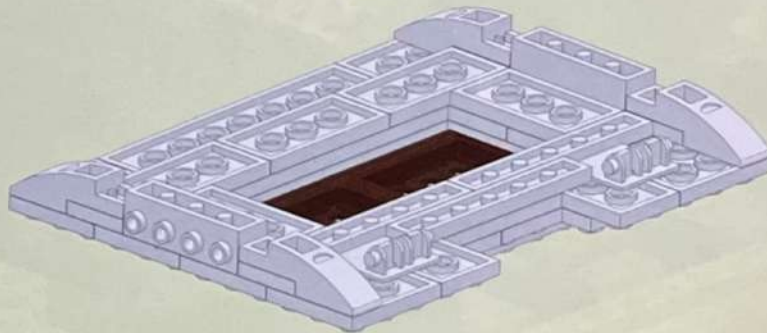
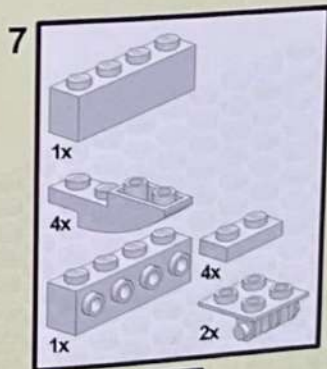
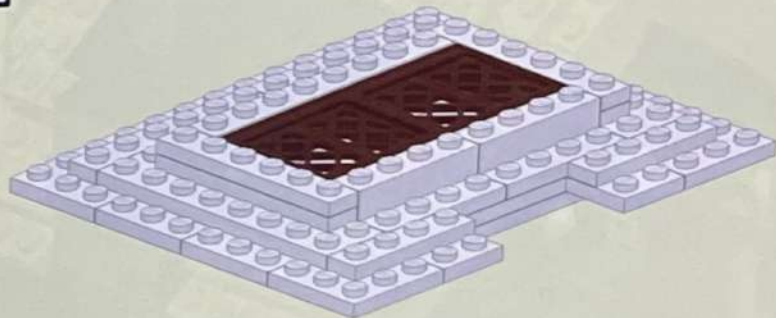
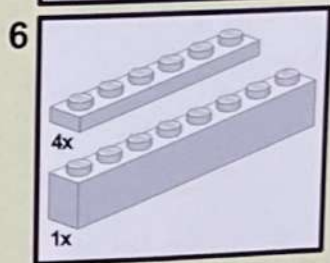
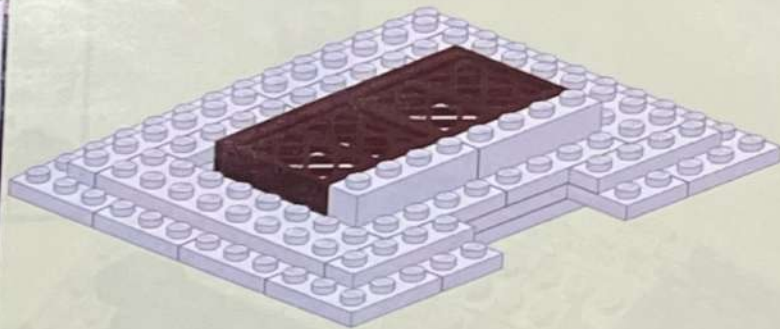
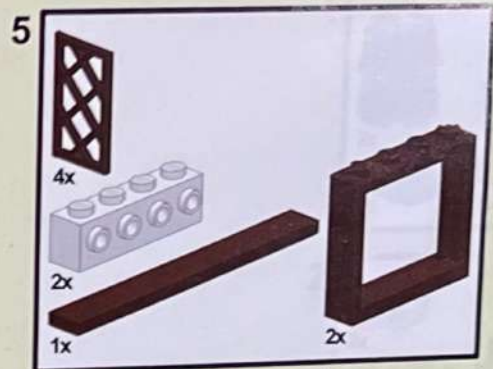



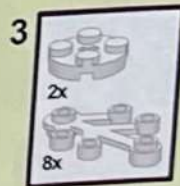
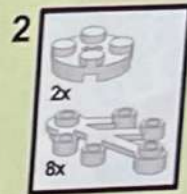

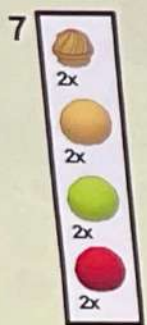
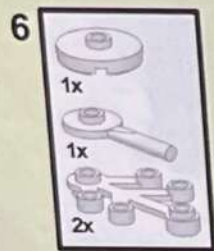
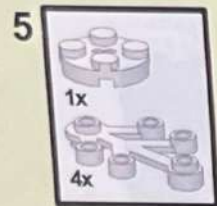







- 1
- 1x
- 6x
- 1x

- 2
- 2x
- 1x
- 2x
- 2x

- 3
- 1x
- 2x
- 1x
- 1x
- 2x



43

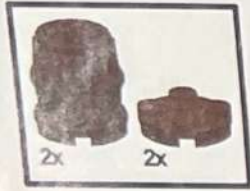

58



